

785 nm Single-Mode/Polarization-Maintaining Pigtail Laser

Dimensions

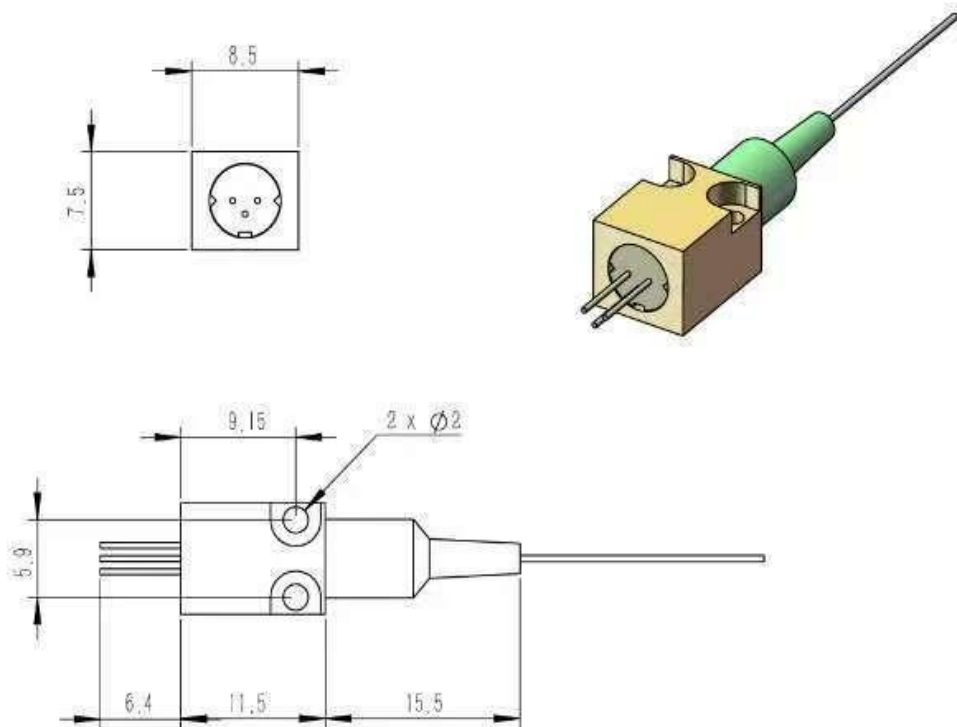

Features:

- High output power
- Excellent beam quality
- High reliability

Applications:

- Spectral analysis
- Biometric detection
- Quantum Technology

785 nm Single-Mode/Polarization-Maintaining Pigtail Laser

Specifications

Parameters	Min.	Typical	Max.	Test Conditions
Optical Properties				
Center Wavelength	780nm	785nm	790nm	At Po = 50mW & Tcase = 25°C
Output Power (Po)		50mW	60mW	At Tcase = 25°C, Iop = 130mA
Power Stability			±1%	
Beam Quality (M ²)			1.1	
Operating Temperature (Tcase)	-10°C	25°C	45°C	Using a base with good heat dissipation.
Electrical Properties				
Threshold Current (Ith)		30mA	50mA	
Operating Current (Iop)		130(mA)	150(mA)	At Po = 50mW & Tcase = 25°C
Operating Voltage (Vop)		2V	2.2V	At Po = 50mW & Tcase = 25°C
Reverse Breakdown Voltage (VR)		2V		
Fiber Type				
Numerical Aperture (NA)		0.13		
Fiber Model	HI780/PM780(5/125)			Customizable
Fiber Length	>1.0 m			Customizable
Ferrule Specifications	0.9 black loose tube			Customizable
Output Connector	Bare fiber or FC/APC			Customizable
Storage Conditions				
Storage Humidity	5% ~ 85% RH			No condensation
Storage Temperature	-20 ~ 60°C			No condensation